

ROUTER-BITS

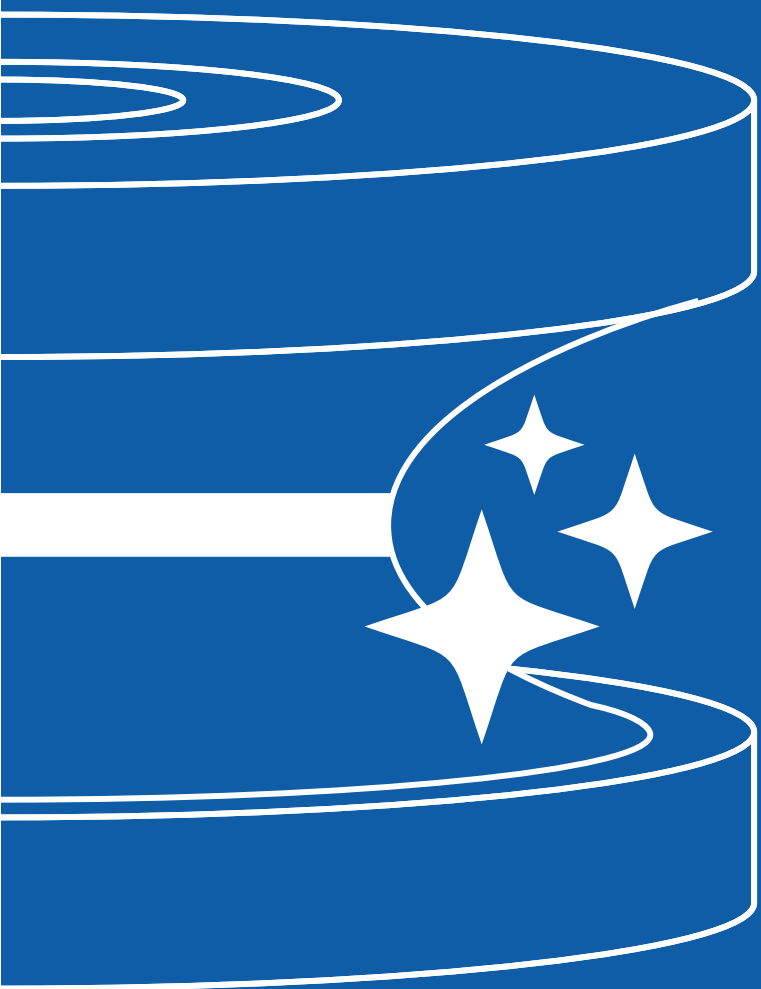

UTENSILI PER MACCHINE MANUALI E SEMI-AUTOMATICHE TOOLS FOR MANUAL AND SEMI-AUTOMATIC MACHINES



Utensili per Macchine Manuali e Semi-automatiche
Tools for Manual and Semi-Automatic Machines

MOLE SAGOMATE LINEA MASTER / LINE MASTER PROFILE WHEELS

KIT PER **GRANITO** / KIT PER **MARMO**
GRANITE SET / MARBLE SET

Kit completo dalla sgrossatura alla lucidatura per macchine MASTER, GHINES ed altre.

Linea completa di mole a profilo da una sgrossatura veloce ad una lucidatura brillante grazie alle tecnologie brevettate Marmoelettromeccanica quali Frangistone e Long-Life. Mole sagomate che possono essere montate su tutte le macchine manuali che lavorano con utensili dotati di tastatore rotante, sia con vite M8 che con vite M10.

Con l'impiego dell'intero kit otterrete: massimo grado di lucentezza, totale assenza di righe ed ondulazioni, lavorazione senza polvere e nessuna lavorazione manuale aggiuntiva.

Complete set for all steps of the polishing process for MASTER, GHINES and other machines.

Complete line of profiling wheels for all steps of the polishing process. They are provided with the exclusive Marmoelettromeccanica technologies, such as Frangistone and Long-Life. These wheels can be mounted on all manual machines that employ rotating touchers with M8 or M10 screws.

By utilizing the entire kit you will obtain: perfect polish, total absence of scratches or lines, reduced production of dust and no need to further rectify by hand.

PROFILI STANDARD / STANDARD PROFILES



!
Su richiesta
è disponibile
qualsiasi altro
profilo

Available any
other profile
on request



SPECIFICHE TECNICHE / TECHNICAL DATA

Foro standard 22,2 mm. Vite: Standard M8 - Su richiesta M10.
Standard bore 22,2 mm. Screw: M8 - or M10 on request.

POS. 00



Mola Pre-Taglio /
Pre-Cutting Wheel

FRANGISTONE

LA MOLA BREVETTATA CHE TAGLIA COSTI E TEMPI
Per velocizzare i tempi di lavorazione offriamo l'innovativa e brevettata mola FRANGISTONE che frantumando già il 60% della pietra riduce costi e tempi di almeno quattro volte rispetto alla tecnologia tradizionale, garantendo una velocissima asportazione ed una lunga durata alle mole successive. Per granito, agglomerati di quarzo e pietre dure.

THE PATENTED WHEEL THAT CUTS COSTS

For the purpose of shortening the working times we offer the new and patented FRANGISTONE wheel, in itself able to grind 60% of the stone, therefore reducing to one fourth at most the delays and expenses of each project. The durability of the second step wheel is also improved.
For granite, quartz and hard stones.

POS. 0



SGROSSATURA VELOCE SU MATERIALI DURI

L'innovativa mola Razorstone, nata dalla tecnologia Frangistone, permette una velocità d'asportazione 5 volte superiore alle mole a settori tradizionali ed ha una durata nettamente superiore, garantendo una lunga durata anche alle mole successive.

FAST GRINDING ON HARD MATERIALS

The new Razorstone wheel, born from Frangistone technology, allows a 5 time faster grinding than the traditional segmented wheels. It has a longer lifespan and grants it to the following wheels too.

POS. 1-2-3



PROFESSIONAL

SGROSSATURA - PROFESSIONALE

Le mole con tastatore rotante per la profilatura che garantiscono eccezionale potere di asportazione e costante mantenimento del profilo per tutta la loro durata, grazie alle nostre tecnologie innovative. Per granito, agglomerati di quarzo, pietre dure e ceramica.

GRINDING - PROFESSIONAL

Profiling wheels with rotating toucher offering the strongest grinding power and an even retention of profile for their entire duration, thanks to our exclusive technologies. For granite, quartz, hard stones and ceramic.

BIPOWER

LA MOLA RETTIFICATRICE CHE NON SI DEFORMA

La mola indeformabile per una perfetta rettifica del profilo. Grazie a questa mola le successive mole lucidanti potranno lavorare in condizioni ottimali per una maggiore durata ed il massimo grado di lucentezza finale. Per granito, agglomerati di quarzo, marmi e pietre.

THE RECTIFICATION WHEEL THAT NEVER LOSES ITS SHAPE

The non-deformable wheel for the perfect profile rectification. Thanks to its work the following polishing wheels will work in ideal conditions, have a longer lifespan and grant the perfect final polishing. For granite, quartz, marble and hard stones.

POS. 4-5-6



LONG LIFE

L'INNOVATIVO SISTEMA DI LUCIDATURA

Costruite con pregiatissimo diamante stampato su corpo elastico, garantiscono una serie di vantaggi quali lunghissima durata, tempi di lavorazione dimezzati, totale assenza di righe, eccezionale grado di lucentezza con risultati insuperabili su marmi, graniti ed agglomerati di quarzo. Per granito, agglomerati di quarzo, marmi e pietre.

THE INNOVATIVE POLISHING SYSTEM

Made with precious diamonds molded onto an elastic rubber core, these tools offer multiply advantages: long life span, reduced process times, absence of lines, outstanding polish and deep gloss on marble, granites and quartz. For granite, quartz, marble and other stones.

POS. 1-2-3



ELETTROLITICA / ELECTROPLATED

SGROSSATURA MARMO

Le mole elettrolitiche, costruite secondo i più moderni ed avanzati sistemi di elettrodeposizione, consentono un ottimo potere di asportazione ed una lunga durata. Per marmi e pietre tenere.

GRINDING - MARBLE

Our electroplated wheels are made following the modern and innovative electroplated process which grants a very good grinding power and a long lifespan. For marble and soft stones.

BIPOWER

LA MOLA RETTIFICATRICE CHE NON SI DEFORMA

La mola indeformabile per una perfetta rettifica del profilo. Grazie a questa mola le successive mole lucidanti potranno lavorare in condizioni ottimali per una maggiore durata ed il massimo grado di lucentezza finale. Per granito, agglomerati di quarzo, marmi e pietre.

THE RECTIFICATION WHEEL THAT NEVER LOSES ITS SHAPE

The non-deformable wheel for the perfect profile rectification. Thanks to its work the following polishing wheels will work in ideal conditions, have a longer lifespan and grant the perfect final polishing. For granite, quartz, marble and hard stones.

POS. 4-5-6



LONG LIFE

L'INNOVATIVO SISTEMA DI LUCIDATURA

Costruite con pregiatissimo diamante stampato su corpo elastico, garantiscono una serie di vantaggi quali lunghissima durata, tempi di lavorazione dimezzati, totale assenza di righe, eccezionale grado di lucentezza con risultati insuperabili su marmi, graniti ed agglomerati di quarzo. Per granito, agglomerati di quarzo, marmi e pietre.

THE INNOVATIVE POLISHING SYSTEM

Made with precious diamonds molded onto an elastic rubber core, these tools offer multiply advantages: long life span, reduced process times, absence of lines, outstanding polish and deep gloss on marble, granites and quartz. For granite, quartz, marble and other stones.

MOLE SAGOMATE LINEA MASTER / LINE MASTER PROFILE WHEELS

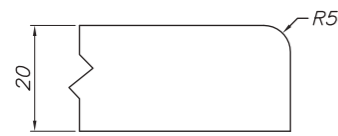

A20 r5

COD.	TIPO MOLA WHEEL TYPE	POS.	MATERIALE MATERIAL
SS21001	Professional	1	○ ○ ○
SS22001	Professional	2	○ ○ ○
SS23001	Bi Power	3	○ ○ ○ ○
SS24001	Long Life	4	○ ○ ○ ○
SS25001	Long Life	5	○ ○ ○ ○
SS26001	Long Life	6	○ ○ ○ ○
SS27001	Elettrolitica / Electroplated	1	○
SS28001	Elettrolitica / Electroplated	2	○

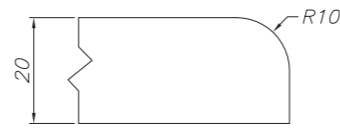

A20 r10

COD.	TIPO MOLA WHEEL TYPE	POS.	MATERIALE MATERIAL
SSR10002	Razorstone	0	○ ○
SS21002	Professional	1	○ ○ ○
SS22002	Professional	2	○ ○ ○
SS23002	Bi Power	3	○ ○ ○ ○
SS24002	Long Life	4	○ ○ ○ ○
SS25002	Long Life	5	○ ○ ○ ○
SS26002	Long Life	6	○ ○ ○ ○
SS27002	Elettrolitica / Electroplated	1	○
SS28002	Elettrolitica / Electroplated	2	○

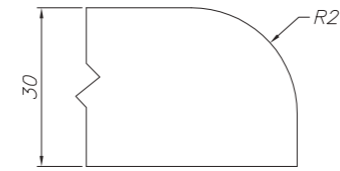

A30 r20

COD.	TIPO MOLA WHEEL TYPE	POS.	MATERIALE MATERIAL
SS32010	Frangistone	00	○ ○
SSR10010	Razorstone	0	○ ○
SS21010	Professional	1	○ ○ ○
SS22010	Professional	2	○ ○ ○
SS23010	Bi Power	3	○ ○ ○ ○
SS24010	Long Life	4	○ ○ ○ ○
SS25010	Long Life	5	○ ○ ○ ○
SS26010	Long Life	6	○ ○ ○ ○
SS27010	Elettrolitica / Electroplated	1	○
SS28010	Elettrolitica / Electroplated	2	○

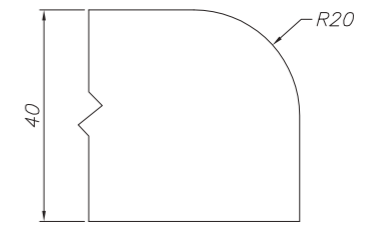

A40 r20

COD.	TIPO MOLA WHEEL TYPE	POS.	MATERIALE MATERIAL
SS32021	Frangistone	00	○ ○
SSR10021	Razorstone	0	○ ○
SS21021	Professional	1	○ ○ ○
SS22021	Professional	2	○ ○ ○
SS23021	Bi Power	3	○ ○ ○ ○
SS24021	Long Life	4	○ ○ ○ ○
SS25021	Long Life	5	○ ○ ○ ○
SS26021	Long Life	6	○ ○ ○ ○
SS27021	Elettrolitica / Electroplated	1	○
SS28021	Elettrolitica / Electroplated	2	○

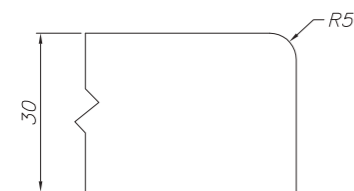

A30 r5

COD.	TIPO MOLA WHEEL TYPE	POS.	MATERIALE MATERIAL
SSR10005	Razorstone	0	○ ○
SS21005	Professional	1	○ ○ ○
SS22005	Professional	2	○ ○ ○
SS23005	Bi Power	3	○ ○ ○ ○
SS24005	Long Life	4	○ ○ ○ ○
SS25005	Long Life	5	○ ○ ○ ○
SS26005	Long Life	6	○ ○ ○ ○
SS27005	Elettrolitica / Electroplated	1	○
SS28005	Elettrolitica / Electroplated	2	○

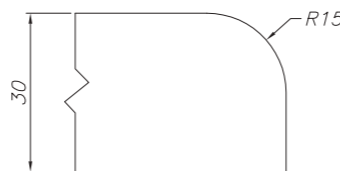

A30 r15

COD.	TIPO MOLA WHEEL TYPE	POS.	MATERIALE MATERIAL
SS32009	Frangistone	00	○ ○
SSR10009	Razorstone	0	○ ○
SS21009	Professional	1	○ ○ ○
SS22009	Professional	2	○ ○ ○
SS23009	Bi Power	3	○ ○ ○ ○
SS24009	Long Life	4	○ ○ ○ ○
SS25009	Long Life	5	○ ○ ○ ○
SS26009	Long Life	6	○ ○ ○ ○
SS27009	Elettrolitica / Electroplated	1	○
SS28009	Elettrolitica / Electroplated	2	○

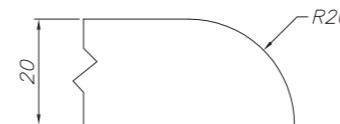

B20

COD.	TIPO MOLA WHEEL TYPE	POS.	MATERIALE MATERIAL
SS32026	Frangistone	00	○ ○
SSR10026	Razorstone	0	○ ○
SS21026	Professional	1	○ ○ ○
SS22026	Professional	2	○ ○ ○
SS23026	Bi Power	3	○ ○ ○ ○
SS24026	Long Life	4	○ ○ ○ ○
SS25026	Long Life	5	○ ○ ○ ○
SS26026	Long Life	6	○ ○ ○ ○
SS27026	Elettrolitica / Electroplated	1	○
SS28026	Elettrolitica / Electroplated	2	○

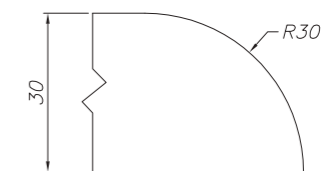

B30

COD.	TIPO MOLA WHEEL TYPE	POS.	MATERIALE MATERIAL
SS32027	Frangistone	00	○ ○
SSR10027	Razorstone	0	○ ○
SS21027	Professional	1	○ ○ ○
SS22027	Professional	2	○ ○ ○
SS23027	Bi Power	3	○ ○ ○ ○
SS24027	Long Life	4	○ ○ ○ ○
SS25027	Long Life	5	○ ○ ○ ○
SS26027	Long Life	6	○ ○ ○ ○
SS27027	Elettrolitica / Electroplated	1	○
SS28027	Elettrolitica / Electroplated	2	○

**LEGENDA MATERIALE
LEGEND MATERIAL:**



**LEGENDA MATERIALE
LEGEND MATERIAL:**



MOLE SAGOMATE LINEA MASTER / LINE MASTER PROFILE WHEELS

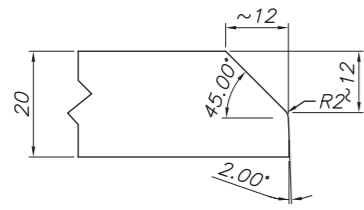

E20

COD.	TIPO MOLA WHEEL TYPE	POS.	MATERIALE MATERIAL
SS32045	Frangistone	00	○ ○
SSR10045	Razorstone	0	○ ○
SS21045	Professional	1	○ ○ ○
SS22045	Professional	2	○ ○ ○
SS23045	Bi Power	3	○ ○ ○ ○
SS24045	Long Life	4	○ ○ ○ ○
SS25045	Long Life	5	○ ○ ○ ○
SS26045	Long Life	6	○ ○ ○ ○
SS27045	Elettrolitica / Electroplated	1	○
SS28045	Elettrolitica / Electroplated	2	○

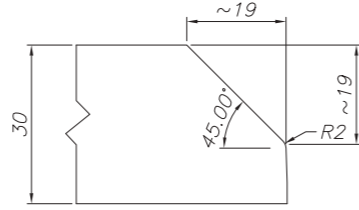

E30

COD.	TIPO MOLA WHEEL TYPE	POS.	MATERIALE MATERIAL
SS32046	Frangistone	00	○ ○
SSR10046	Razorstone	0	○ ○
SS21046	Professional	1	○ ○ ○
SS22046	Professional	2	○ ○ ○
SS23046	Bi Power	3	○ ○ ○ ○
SS24046	Long Life	4	○ ○ ○ ○
SS25046	Long Life	5	○ ○ ○ ○
SS26046	Long Life	6	○ ○ ○ ○
SS27046	Elettrolitica / Electroplated	1	○
SS28046	Elettrolitica / Electroplated	2	○

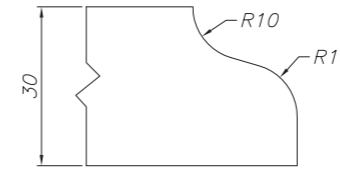

FZ30

COD.	TIPO MOLA WHEEL TYPE	POS.	MATERIALE MATERIAL
SS32074	Frangistone	00	○ ○
SSR10074	Razorstone	0	○ ○
SS21074	Professional	1	○ ○ ○
SS22074	Professional	2	○ ○ ○
SS23074	Bi Power	3	○ ○ ○ ○
SS24074	Long Life	4	○ ○ ○ ○
SS25074	Long Life	5	○ ○ ○ ○
SS26074	Long Life	6	○ ○ ○ ○
SS27074	Elettrolitica / Electroplated	1	○
SS28074	Elettrolitica / Electroplated	2	○

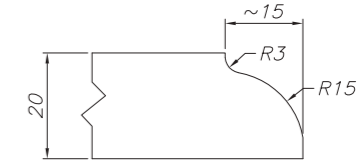

H20

COD.	TIPO MOLA WHEEL TYPE	POS.	MATERIALE MATERIAL
SS32056	Frangistone	00	○ ○
SSR10056	Razorstone	0	○ ○
SS21056	Professional	1	○ ○ ○
SS22056	Professional	2	○ ○ ○
SS23056	Bi Power	3	○ ○ ○ ○
SS24056	Long Life	4	○ ○ ○ ○
SS25056	Long Life	5	○ ○ ○ ○
SS26056	Long Life	6	○ ○ ○ ○
SS27056	Elettrolitica / Electroplated	1	○
SS28056	Elettrolitica / Electroplated	2	○

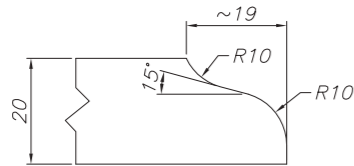

F20

COD.	TIPO MOLA WHEEL TYPE	POS.	MATERIALE MATERIAL
SS32049	Frangistone	00	○ ○
SSR10049	Razorstone	0	○ ○
SS21049	Professional	1	○ ○ ○
SS22049	Professional	2	○ ○ ○
SS23049	Bi Power	3	○ ○ ○ ○
SS24049	Long Life	4	○ ○ ○ ○
SS25049	Long Life	5	○ ○ ○ ○
SS26049	Long Life	6	○ ○ ○ ○
SS27049	Elettrolitica / Electroplated	1	○
SS28049	Elettrolitica / Electroplated	2	○

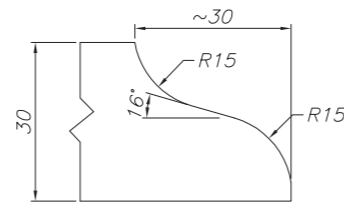

F30

COD.	TIPO MOLA WHEEL TYPE	POS.	MATERIALE MATERIAL
SS32050	Frangistone	00	○ ○
SSR10050	Razorstone	0	○ ○
SS21050	Professional	1	○ ○ ○
SS22050	Professional	2	○ ○ ○
SS23050	Bi Power	3	○ ○ ○ ○
SS24050	Long Life	4	○ ○ ○ ○
SS25050	Long Life	5	○ ○ ○ ○
SS26050	Long Life	6	○ ○ ○ ○
SS27050	Elettrolitica / Electroplated	1	○
SS28050	Elettrolitica / Electroplated	2	○

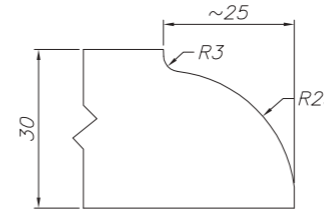

H30

COD.	TIPO MOLA WHEEL TYPE	POS.	MATERIALE MATERIAL
SS32057	Frangistone	00	○ ○
SSR10057	Razorstone	0	○ ○
SS21057	Professional	1	○ ○ ○
SS22057	Professional	2	○ ○ ○
SS23057	Bi Power	3	○ ○ ○ ○
SS24057	Long Life	4	○ ○ ○ ○
SS25057	Long Life	5	○ ○ ○ ○
SS26057	Long Life	6	○ ○ ○ ○
SS27057	Elettrolitica / Electroplated	1	○
SS28057	Elettrolitica / Electroplated	2	○

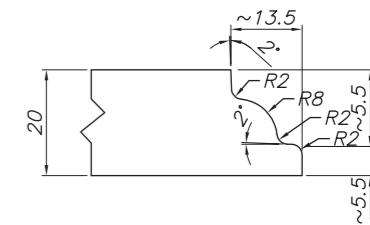

H+A20

COD.	TIPO MOLA WHEEL TYPE	POS.	MATERIALE MATERIAL
SS32059	Frangistone	00	○ ○
SSR10059	Razorstone	0	○ ○
SS21059	Professional	1	○ ○ ○
SS22059	Professional	2	○ ○ ○
SS23059	Bi Power	3	○ ○ ○ ○
SS24059	Long Life	4	○ ○ ○ ○
SS25059	Long Life	5	○ ○ ○ ○
SS26059	Long Life	6	○ ○ ○ ○
SS27059	Elettrolitica / Electroplated	1	○
SS28059	Elettrolitica / Electroplated	2	○

**LEGENDA MATERIALE
LEGEND MATERIAL:**



**LEGENDA MATERIALE
LEGEND MATERIAL:**



MOLE SAGOMATE LINEA MASTER / LINE MASTER PROFILE WHEELS

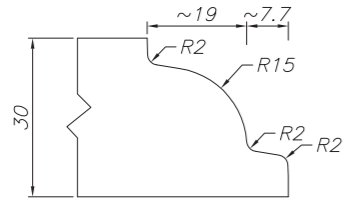

H+A30

COD.	TIPO MOLA WHEEL TYPE	POS.	MATERIALE MATERIAL
SS32060	Frangistone	00	○ ○
SSR10060	Razorstone	0	○ ○
SS21060	Professional	1	○ ○ ○
SS22060	Professional	2	○ ○ ○
SS23060	Bi Power	3	○ ○ ○ ○
SS24060	Long Life	4	○ ○ ○ ○
SS25060	Long Life	5	○ ○ ○ ○
SS26060	Long Life	6	○ ○ ○ ○
SS27060	Elettrolitica / Electroplated	1	○
SS28060	Elettrolitica / Electroplated	2	○

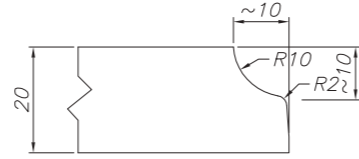

L20

COD.	TIPO MOLA WHEEL TYPE	POS.	MATERIALE MATERIAL
SS32064	Frangistone	00	○ ○
SSR10064	Razorstone	0	○ ○
SS21064	Professional	1	○ ○ ○
SS22064	Professional	2	○ ○ ○
SS23064	Bi Power	3	○ ○ ○ ○
SS24064	Long Life	4	○ ○ ○ ○
SS25064	Long Life	5	○ ○ ○ ○
SS26064	Long Life	6	○ ○ ○ ○
SS27064	Elettrolitica / Electroplated	1	○
SS28064	Elettrolitica / Electroplated	2	○

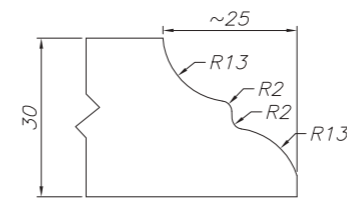

O30

COD.	TIPO MOLA WHEEL TYPE	POS.	MATERIALE MATERIAL
SS32071	Frangistone	00	○ ○
SSR10071	Razorstone	0	○ ○
SS21071	Professional	1	○ ○ ○
SS22071	Professional	2	○ ○ ○
SS23071	Bi Power	3	○ ○ ○ ○
SS24071	Long Life	4	○ ○ ○ ○
SS25071	Long Life	5	○ ○ ○ ○
SS26071	Long Life	6	○ ○ ○ ○
SS27071	Elettrolitica / Electroplated	1	○
SS28071	Elettrolitica / Electroplated	2	○

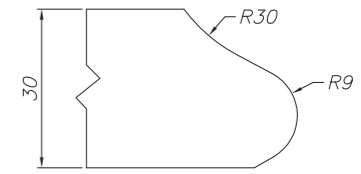

OG30

COD.	TIPO MOLA WHEEL TYPE	POS.	MATERIALE MATERIAL
SS32152	Frangistone	00	○ ○
SSR10152	Razorstone	0	○ ○
SS21152	Professional	1	○ ○ ○
SS22152	Professional	2	○ ○ ○
SS23152	Bi Power	3	○ ○ ○ ○
SS24152	Long Life	4	○ ○ ○ ○
SS25152	Long Life	5	○ ○ ○ ○
SS26152	Long Life	6	○ ○ ○ ○
SS27152	Elettrolitica / Electroplated	1	○
SS28152	Elettrolitica / Electroplated	2	○

Utensili per Macchine Manuali e Semi-automatiche
Tools for Manual and Semi-Automatic Machines

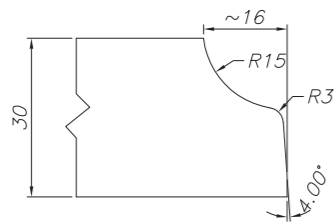

L30

COD.	TIPO MOLA WHEEL TYPE	POS.	MATERIALE MATERIAL
SS32065	Frangistone	00	○ ○
SSR10065	Razorstone	0	○ ○
SS21065	Professional	1	○ ○ ○
SS22065	Professional	2	○ ○ ○
SS23065	Bi Power	3	○ ○ ○ ○
SS24065	Long Life	4	○ ○ ○ ○
SS25065	Long Life	5	○ ○ ○ ○
SS26065	Long Life	6	○ ○ ○ ○
SS27065	Elettrolitica / Electroplated	1	○
SS28065	Elettrolitica / Electroplated	2	○

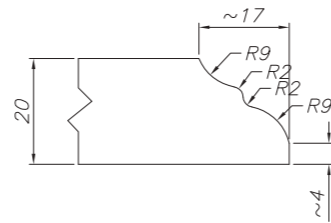

O20

COD.	TIPO MOLA WHEEL TYPE	POS.	MATERIALE MATERIAL
SS32070	Frangistone	00	○ ○
SSR10070	Razorstone	0	○ ○
SS21070	Professional	1	○ ○ ○
SS22070	Professional	2	○ ○ ○
SS23070	Bi Power	3	○ ○ ○ ○
SS24070	Long Life	4	○ ○ ○ ○
SS25070	Long Life	5	○ ○ ○ ○
SS26070	Long Life	6	○ ○ ○ ○
SS27070	Elettrolitica / Electroplated	1	○
SS28070	Elettrolitica / Electroplated	2	○

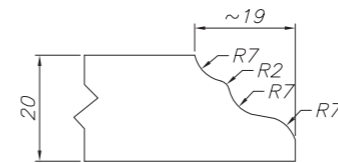

Q20

COD.	TIPO MOLA WHEEL TYPE	POS.	MATERIALE MATERIAL
SS32077	Frangistone	00	○ ○
SSR10077	Razorstone	0	○ ○
SS21077	Professional	1	○ ○ ○
SS22077	Professional	2	○ ○ ○
SS23077	Bi Power	3	○ ○ ○ ○
SS24077	Long Life	4	○ ○ ○ ○
SS25077	Long Life	5	○ ○ ○ ○
SS26077	Long Life	6	○ ○ ○ ○
SS27077	Elettrolitica / Electroplated	1	○
SS28077	Elettrolitica / Electroplated	2	○

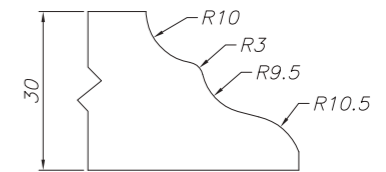

Q30

COD.	TIPO MOLA WHEEL TYPE	POS.	MATERIALE MATERIAL
SS32078	Frangistone	00	○ ○
SSR10078	Razorstone	0	○ ○
SS21078	Professional	1	○ ○ ○
SS22078	Professional	2	○ ○ ○
SS23078	Bi Power	3	○ ○ ○ ○
SS24078	Long Life	4	○ ○ ○ ○
SS25078	Long Life	5	○ ○ ○ ○
SS26078	Long Life	6	○ ○ ○ ○
SS27078	Elettrolitica / Electroplated	1	○
SS28078	Elettrolitica / Electroplated	2	○

**LEGENDA MATERIALE
LEGEND MATERIAL:**



**LEGENDA MATERIALE
LEGEND MATERIAL:**



MOLE SAGOMATE LINEA MASTER / LINE MASTER PROFILE WHEELS

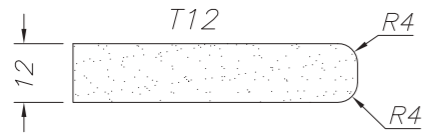

T12

COD.	TIPO MOLA WHEEL TYPE	POS.	MATERIALE MATERIAL
SS22243	Professional	2	● ● ●
SS23243	Bi Power	3	● ● ● ●
SS24243	Long Life	4	● ● ● ● ●
SS25243	Long Life	5	● ● ● ● ● ●
SS26243	Long Life	6	● ● ● ● ● ● ●



T20 r3

COD.	TIPO MOLA WHEEL TYPE	POS.	MATERIALE MATERIAL
SS21114	Professional	1	● ● ●
SS22114	Professional	2	● ● ● ●
SS23114	Bi Power	3	● ● ● ● ●
SS24114	Long Life	4	● ● ● ● ● ●
SS25114	Long Life	5	● ● ● ● ● ● ●
SS26114	Long Life	6	● ● ● ● ● ● ● ●
SS27114	Elettrolitica / Electroplated	1	○
SS28114	Elettrolitica / Electroplated	2	○

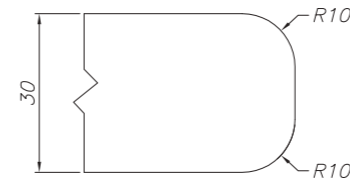

T30 r10

COD.	TIPO MOLA WHEEL TYPE	POS.	MATERIALE MATERIAL
SSR10081	Razorstone	0	● ●
SS21081	Professional	1	● ● ● ●
SS22081	Professional	2	● ● ● ● ●
SS23081	Bi Power	3	● ● ● ● ● ●
SS24081	Long Life	4	● ● ● ● ● ● ●
SS25081	Long Life	5	● ● ● ● ● ● ● ●
SS26081	Long Life	6	● ● ● ● ● ● ● ● ●
SS27081	Elettrolitica / Electroplated	1	○
SS28081	Elettrolitica / Electroplated	2	○

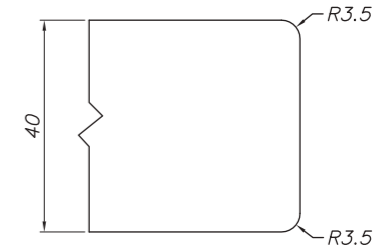

T40 r3,5

COD.	TIPO MOLA WHEEL TYPE	POS.	MATERIALE MATERIAL
SSR10117	Razorstone	0	● ●
SS21117	Professional	1	● ● ● ●
SS22117	Professional	2	● ● ● ● ●
SS23117	Bi Power	3	● ● ● ● ● ●
SS24117	Long Life	4	● ● ● ● ● ● ●
SS25117	Long Life	5	● ● ● ● ● ● ● ●
SS26117	Long Life	6	● ● ● ● ● ● ● ● ●
SS27117	Elettrolitica / Electroplated	1	○
SS28117	Elettrolitica / Electroplated	2	○

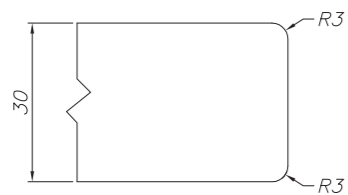

T30 r3

COD.	TIPO MOLA WHEEL TYPE	POS.	MATERIALE MATERIAL
SSR10115	Razorstone	0	● ●
SS21115	Professional	1	● ● ● ●
SS22115	Professional	2	● ● ● ● ●
SS23115	Bi Power	3	● ● ● ● ● ●
SS24115	Long Life	4	● ● ● ● ● ● ●
SS25115	Long Life	5	● ● ● ● ● ● ● ●
SS26115	Long Life	6	● ● ● ● ● ● ● ● ●
SS27115	Elettrolitica / Electroplated	1	○
SS28115	Elettrolitica / Electroplated	2	○

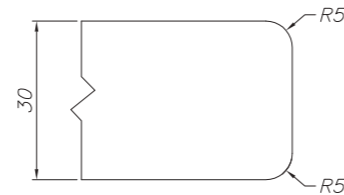

T30 r5

COD.	TIPO MOLA WHEEL TYPE	POS.	MATERIALE MATERIAL
SSR10082	Razorstone	0	● ●
SS21082	Professional	1	● ● ● ●
SS22082	Professional	2	● ● ● ● ●
SS23082	Bi Power	3	● ● ● ● ● ●
SS24082	Long Life	4	● ● ● ● ● ● ●
SS25082	Long Life	5	● ● ● ● ● ● ● ●
SS26082	Long Life	6	● ● ● ● ● ● ● ● ●
SS27082	Elettrolitica / Electroplated	1	○
SS28082	Elettrolitica / Electroplated	2	○

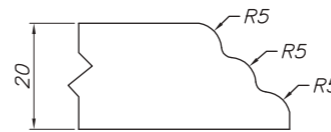

TP20

COD.	TIPO MOLA WHEEL TYPE	POS.	MATERIALE MATERIAL
SS32029	Frangistone	00	● ●
SSR10029	Razorstone	0	● ● ● ●
SS21029	Professional	1	● ● ● ● ●
SS22029	Professional	2	● ● ● ● ● ●
SS23029	Bi Power	3	● ● ● ● ● ● ●
SS24029	Long Life	4	● ● ● ● ● ● ● ●
SS25029	Long Life	5	● ● ● ● ● ● ● ● ●
SS26029	Long Life	6	● ● ● ● ● ● ● ● ● ●
SS27029	Elettrolitica / Electroplated	1	○
SS28029	Elettrolitica / Electroplated	2	○

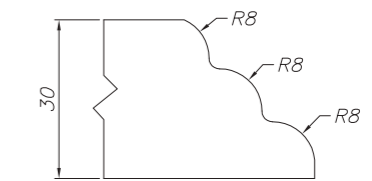

TP30

COD.	TIPO MOLA WHEEL TYPE	POS.	MATERIALE MATERIAL
SS32030	Frangistone	00	● ●
SSR10030	Razorstone	0	● ● ● ●
SS21030	Professional	1	● ● ● ● ●
SS22030	Professional	2	● ● ● ● ● ●
SS23030	Bi Power	3	● ● ● ● ● ● ●
SS24030	Long Life	4	● ● ● ● ● ● ● ●
SS25030	Long Life	5	● ● ● ● ● ● ● ● ●
SS26030	Long Life	6	● ● ● ● ● ● ● ● ● ●
SS27030	Elettrolitica / Electroplated	1	○
SS28030	Elettrolitica / Electroplated	2	○

**LEGENDA MATERIALE
LEGEND MATERIAL:**



**LEGENDA MATERIALE
LEGEND MATERIAL:**



MOLE SAGOMATE LINEA MASTER / LINE MASTER PROFILE WHEELS

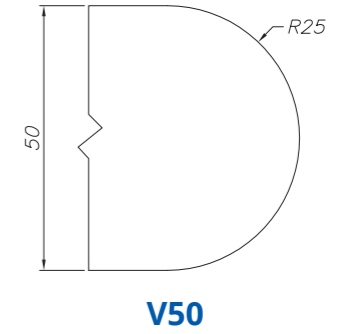
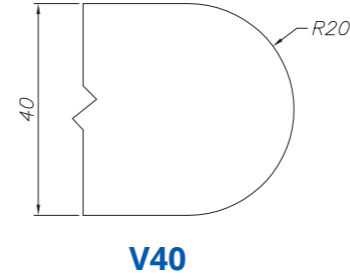
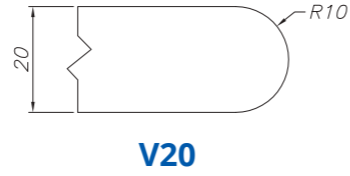
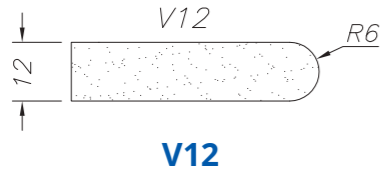

COD.	TIPO MOLA WHEEL TYPE	POS.	MATERIALE MATERIAL
SS22269	Professional	2	● ● ●
SS23269	Bi Power	3	● ● ● ●
SS24269	Long Life	4	● ● ● ● ●
SS25269	Long Life	5	● ● ● ● ● ●
SS26269	Long Life	6	● ● ● ● ● ●

COD.	TIPO MOLA WHEEL TYPE	POS.	MATERIALE MATERIAL
SSR10087	Razorstone	0	○ ○
SS21087	Professional	1	● ● ●
SS22087	Professional	2	● ● ●
SS23087	Bi Power	3	● ● ● ●
SS24087	Long Life	4	● ● ● ● ●
SS25087	Long Life	5	● ● ● ● ● ●
SS26087	Long Life	6	● ● ● ● ● ●
SS27087	Elettrolitica / Electroplated	1	○
SS28087	Elettrolitica / Electroplated	2	○

COD.	TIPO MOLA WHEEL TYPE	POS.	MATERIALE MATERIAL
SS32090	Frangistone	00	○ ○
SSR10090	Razorstone	0	○ ○
SS21090	Professional	1	● ● ●
SS22090	Professional	2	● ● ●
SS23090	Bi Power	3	● ● ● ●
SS24090	Long Life	4	● ● ● ● ●
SS25090	Long Life	5	● ● ● ● ● ●
SS26090	Long Life	6	● ● ● ● ● ●
SS27090	Elettrolitica / Electroplated	1	○
SS28090	Elettrolitica / Electroplated	2	○

COD.	TIPO MOLA WHEEL TYPE	POS.	MATERIALE MATERIAL
SS32092	Frangistone	00	○ ○
SSR10092	Razorstone	0	○ ○
SS21092	Professional	1	● ● ●
SS22092	Professional	2	● ● ●
SS23092	Bi Power	3	● ● ● ●
SS24092	Long Life	4	● ● ● ● ●
SS25092	Long Life	5	● ● ● ● ● ●
SS26092	Long Life	6	● ● ● ● ● ●
SS27092	Elettrolitica / Electroplated	1	○
SS28092	Elettrolitica / Electroplated	2	○

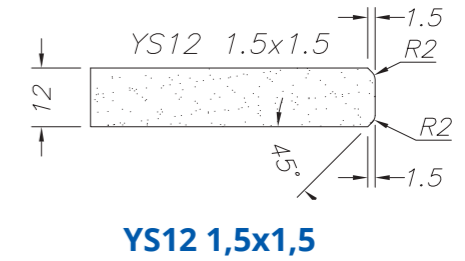
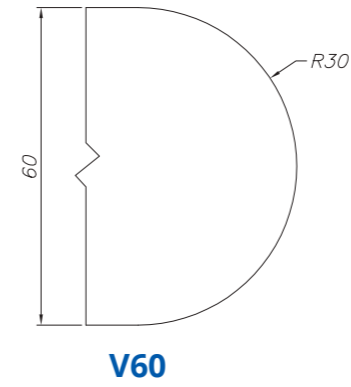
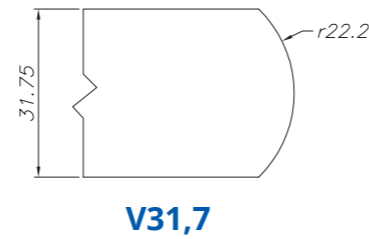
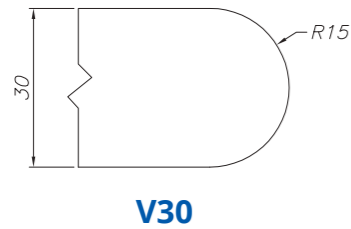

COD.	TIPO MOLA WHEEL TYPE	POS.	MATERIALE MATERIAL
SS32088	Frangistone	00	○ ○
SSR10088	Razorstone	0	○ ○
SS21088	Professional	1	● ● ●
SS22088	Professional	2	● ● ●
SS23088	Bi Power	3	● ● ● ●
SS24088	Long Life	4	● ● ● ● ●
SS25088	Long Life	5	● ● ● ● ● ●
SS26088	Long Life	6	● ● ● ● ● ●
SS27088	Elettrolitica / Electroplated	1	○
SS28088	Elettrolitica / Electroplated	2	○

COD.	TIPO MOLA WHEEL TYPE	POS.	MATERIALE MATERIAL
SSR10089	Razorstone	0	○ ○
SS21089	Professional	1	● ● ●
SS22089	Professional	2	● ● ●
SS23089	Bi Power	3	● ● ● ●
SS24089	Long Life	4	● ● ● ● ●
SS25089	Long Life	5	● ● ● ● ● ●
SS26089	Long Life	6	● ● ● ● ● ●
SS27089	Elettrolitica / Electroplated	1	○
SS28089	Elettrolitica / Electroplated	2	○

COD.	TIPO MOLA WHEEL TYPE	POS.	MATERIALE MATERIAL
SS32093	Frangistone	00	○ ○
SSR10093	Razorstone	0	○ ○
SS21093	Professional	1	● ● ●
SS22093	Professional	2	● ● ●
SS23093	Bi Power	3	● ● ● ●
SS24093	Long Life	4	● ● ● ● ●
SS25093	Long Life	5	● ● ● ● ● ●
SS26093	Long Life	6	● ● ● ● ● ●
SS27093	Elettrolitica / Electroplated	1	○
SS28093	Elettrolitica / Electroplated	2	○

COD.	TIPO MOLA WHEEL TYPE	POS.	MATERIALE MATERIAL
SS22274	Professional	2	● ● ●
SS23274	Bi Power	3	● ● ● ●
SS24274	Long Life	4	● ● ● ● ●
SS25274	Long Life	5	● ● ● ● ● ●
SS26274	Long Life	6	● ● ● ● ● ●

**LEGENDA MATERIALE
LEGEND MATERIAL:**



**LEGENDA MATERIALE
LEGEND MATERIAL:**



MOLE SAGOMATE LINEA MASTER / LINE MASTER PROFILE WHEELS

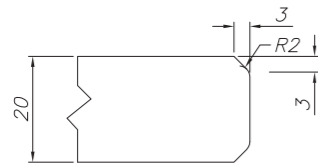

YS20 3x3

COD.	TIPO MOLA WHEEL TYPE	POS.	MATERIALE MATERIAL
SSR10120	Razorstone	0	○ ○
SS21120	Professional	1	○ ○ ○
SS22120	Professional	2	○ ○ ○
SS23120	Bi Power	3	○ ○ ○ ○
SS24120	Long Life	4	○ ○ ○ ○
SS25120	Long Life	5	○ ○ ○ ○
SS26120	Long Life	6	○ ○ ○ ○
SS27120	Elettrolitica / Electroplated	1	○
SS28120	Elettrolitica / Electroplated	2	○

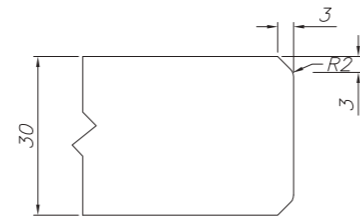

YS30 3x3

COD.	TIPO MOLA WHEEL TYPE	POS.	MATERIALE MATERIAL
SSR10121	Razorstone	0	○ ○
SS21121	Professional	1	○ ○ ○
SS22121	Professional	2	○ ○ ○
SS23121	Bi Power	3	○ ○ ○ ○
SS24121	Long Life	4	○ ○ ○ ○
SS25121	Long Life	5	○ ○ ○ ○
SS26121	Long Life	6	○ ○ ○ ○
SS27121	Elettrolitica / Electroplated	1	○
SS28121	Elettrolitica / Electroplated	2	○

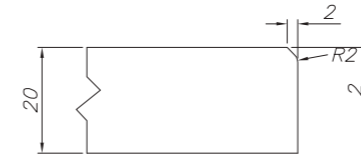

ZS20

COD.	TIPO MOLA WHEEL TYPE	POS.	MATERIALE MATERIAL
SS21040	Professional	1	○ ○ ○
SS22040	Professional	2	○ ○ ○
SS23040	Bi Power	3	○ ○ ○ ○
SS24040	Long Life	4	○ ○ ○ ○
SS25040	Long Life	5	○ ○ ○ ○
SS26040	Long Life	6	○ ○ ○ ○
SS27040	Elettrolitica / Electroplated	1	○
SS28040	Elettrolitica / Electroplated	2	○

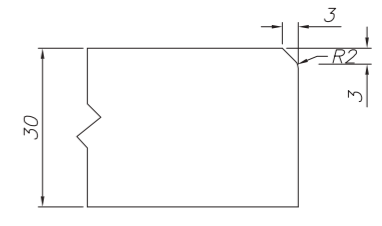

ZS30

COD.	TIPO MOLA WHEEL TYPE	POS.	MATERIALE MATERIAL
SS21041	Professional	1	○ ○ ○
SS22041	Professional	2	○ ○ ○
SS23041	Bi Power	3	○ ○ ○ ○
SS24041	Long Life	4	○ ○ ○ ○
SS25041	Long Life	5	○ ○ ○ ○
SS26041	Long Life	6	○ ○ ○ ○
SS27041	Elettrolitica / Electroplated	1	○
SS28041	Elettrolitica / Electroplated	2	○

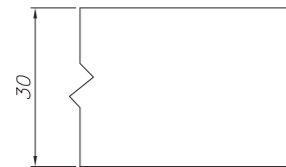

Z30

COD.	TIPO MOLA WHEEL TYPE	POS.	MATERIALE MATERIAL
SSR10034	Razorstone	0	○ ○
SS21034	Professional	1	○ ○ ○
SS22034	Professional	2	○ ○ ○
SS23034	Bi Power	3	○ ○ ○ ○
SS24034	Long Life	4	○ ○ ○ ○
SS25034	Long Life	5	○ ○ ○ ○
SS26034	Long Life	6	○ ○ ○ ○
SS27034	Elettrolitica / Electroplated	1	○
SS28034	Elettrolitica / Electroplated	2	○

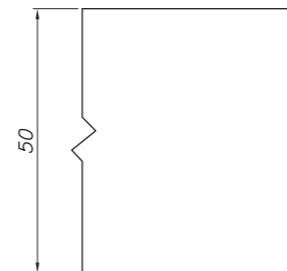

Z50

COD.	TIPO MOLA WHEEL TYPE	POS.	MATERIALE MATERIAL
SSR10036	Razorstone	0	○ ○
SS21036	Professional	1	○ ○ ○
SS22036	Professional	2	○ ○ ○
SS23036	Bi Power	3	○ ○ ○ ○
SS24036	Long Life	4	○ ○ ○ ○
SS25036	Long Life	5	○ ○ ○ ○
SS26036	Long Life	6	○ ○ ○ ○
SS27036	Elettrolitica / Electroplated	1	○
SS28036	Elettrolitica / Electroplated	2	○

**LEGENDA MATERIALE
LEGEND MATERIAL:**



**LEGENDA MATERIALE
LEGEND MATERIAL:**



MOLE SAGOMATE LINEA MASTER / LINE MASTER PROFILE WHEELS



**FRESA DI RETTIFICA /
RECTIFICATION TOOL**

A settori / Segmented

COD.	Ø (mm)	H (mm)	MATERIALE MATERIAL
SS05001	80,0	33,0	○ ○
SS05002	80,0	43,0	○ ○

È indispensabile per la rettifica del bordo interno del foro dei top. Prepara il profilo alla scontornatura e alla lucidatura.

Essential for processing the internal rim of the top's hole. Prepares the edge for grinding and polishing.



**FRESA DI RETTIFICA /
RECTIFICATION TOOL**

A fascia continua / Continuous rim

COD.	Ø (mm)	H (mm)	MATERIALE MATERIAL
SS05013	40,0	35,0	○ ○ ○

È indispensabile per la rettifica del bordo interno del foro dei top. Prepara il profilo alla scontornatura e alla lucidatura.

Essential for processing the internal rim of the top's hole. Prepares the edge for grinding and polishing.



**DISCO DI RETTIFICA /
RECTIFICATION TOOL**

Sinterizzato o Elettrolitico / Sintered or Electroplated

COD.	SPESSORE THICKNESS	MATERIALE MATERIAL
SS06005	30,0	○ ○ ○ ○

I dischi rettifica di quota sono realizzati per essere montati in maniera semplice ed intuitiva sulle mole Marmoelettromeccanica posizione 1.

These tools are easily and quickly mounted on Marmoelettromeccanica's wheels for position 1.



**TASTATORE ROTANTE /
ROTATING TOUCHER**

In acciaio / Steel

COD.	DESCRIZIONE DESCRIPTION
SA04001	Per mole sagomate profili aperti / For open profile wheels
SA04002	Per mole sagomate profili chiusi / For closed profile wheels
SA04003	Per mole frangistone profili aperti / For open Frangistone wheels
SA04004	Per mole Frangistone profili chiusi / For closed Frangistone wheels

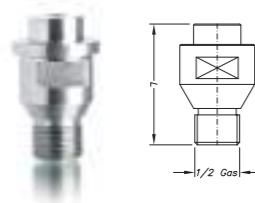

**ADATTATORE 1/2 GAS /
ADAPTOR 1/2" GAS THREAD**

In acciaio / Steel

COD.	L (mm)
SA03001	60,0

LEGENDA MATERIALE
LEGEND MATERIAL:



LEGENDA MATERIALE
LEGEND MATERIAL:



VITI A TENÒ PER MONTAGGIO MOLE /
TENÒ SCREWS FOR WHEELS

In acciaio / Steel

FILETTATURA
THREAD

M8

M10

POS. 0 FRANGISTONE

M8 M10

PROFILO PROFILES	COD.	DIMENSIONE DIMENSION	COD.	DIMENSIONE DIMENSION
A20 r10	SA06004	M8 x 15	SA07004	M10 x 15
A30 r5	-	-	-	-
A30 r15	SA06004	M8 x 15	SA07004	M10 x 15
A30 r20	SA06004	M8 x 15	SA07004	M10 x 15
A40 r20	SA06004	M8 x 20	SA07004	M10 x 20
B20	SA06004	M8 x 15	SA07004	M10 x 15
B30	SA06007	M8 x 25	SA07007	M10 x 25
E30	SA06006	M8 x 20	SA07006	M10 x 20
F20	SA06006	M8 x 20	SA07006	M10 x 20
F30	SA06008	M8 x 30	SA07008	M10 x 30
FZ30	SA06006	M8 x 20	SA07006	M10 x 20
H20	SA06004	M8 x 15	SA07004	M10 x 15
H30	SA06006	M8 x 20	SA07006	M10 x 20
H+A30	SA06006	M8 x 20	SA07006	M10 x 20
L20	SA06004	M8 x 15	SA07004	M10 x 15
L30	SA06006	M8 x 20	SA07006	M10 x 20
O20	SA06006	M8 x 20	SA07006	M10 x 20
O30	SA06007	M8 x 25	SA07007	M10 x 25
OG30	SA06006	M8 x 20	SA07006	M10 x 20
Q20	SA06006	M8 x 20	SA07006	M10 x 20
Q30	SA06007	M8 x 25	SA07007	M10 x 25
T20 r5	-	-	-	-
T30 r3	-	-	-	-
T30 r5	-	-	-	-
T30 r10	SA06004	M8 x 15	SA07004	M10 x 15
T40 r3,5	-	-	-	-
TP30	SA06007	M8 x 25	SA07007	M10 x 25
V20	SA06004	M8 x 15	SA07004	M10 x 15
V30	SA06004	M8 x 15	SA07004	M10 x 15
V31,7	-	-	-	-
V40	SA06007	M8 x 25	SA07007	M10 x 25
V50	SA06009	M8 x 35	SA07009	M10 x 35
V60	SA06011	M8 x 45	SA07011	M10 x 45
YS20 3x3	-	-	-	-
YS30 3x3	-	-	-	-
Z30	-	-	-	-
ZS20	-	-	-	-
ZS30	-	-	-	-

POS. 1 - POS. 2

M8 M10

PROFILO PROFILES	COD.	DIMENSIONE DIMENSION	COD.	DIMENSIONE DIMENSION
A20 r10	SA06004	M8 x 15	SA07004	M10 x 15
A30 r5	SA06006	M8 x 20	SA07006	M10 x 20
A30 r15	SA06006	M8 x 20	SA07006	M10 x 20
A30 r20	SA06006	M8 x 20	SA07006	M10 x 20
A40 r20	SA06008	M8 x 30	SA07008	M10 x 30
B20	SA06004	M8 x 15	SA07004	M10 x 15
B30	SA06006	M8 x 20	SA07006	M10 x 20
E30	SA06006	M8 x 20	SA07006	M10 x 20
F20	SA06004	M8 x 15	SA07004	M10 x 15
F30	SA06007	M8 x 25	SA07007	M10 x 25
FZ30	SA06006	M8 x 20	SA07006	M10 x 20
H20	SA06004	M8 x 15	SA07004	M10 x 15
H30	SA06004	M8 x 15	SA07004	M10 x 15
H+A30	SA06004	M8 x 15	SA07004	M10 x 15
L20	SA06004	M8 x 15	SA07004	M10 x 15
L30	SA06007	M8 x 25	SA07007	M10 x 25
O20	SA06004	M8 x 15	SA07004	M10 x 15
O30	SA06004	M8 x 15	SA07004	M10 x 15
OG30	SA06006	M8 x 20	SA07006	M10 x 20
Q20	SA06004	M8 x 15	SA07004	M10 x 15
Q30	SA06006	M8 x 20	SA07006	M10 x 20
T20 r5	SA06004	M8 x 15	SA07004	M10 x 15
T30 r3	SA06006	M8 x 20	SA07006	M10 x 20
T30 r5	SA06007	M8 x 25	SA07007	M10 x 25
T30 r10	SA06004	M8 x 15	SA07004	M10 x 15
T40 r3,5	SA06009	M8 x 35	SA07009	M10 x 35
TP30	SA06006	M8 x 20	SA07006	M10 x 20
V20	SA06004	M8 x 15	SA07004	M10 x 15
V30	SA06004	M8 x 15	SA07004	M10 x 15
V31,7	SA06004	M8 x 15	SA07004	M10 x 15
V40	SA06006	M8 x 20	SA07006	M10 x 20
V50	SA06009	M8 x 35	SA07009	M10 x 35
V60	SA06010	M8 x 40	SA07010	M10 x 40
YS20 3x3	SA06004	M8 x 15	SA07004	M10 x 15
YS30 3x3	SA06007	M8 x 25	SA07007	M10 x 25
Z30	SA06004	M8 x 15	SA07004	M10 x 15
ZS20	SA06004	M8 x 15	SA07004	M10 x 15
ZS30	SA06007	M8 x 15	SA07007	M10 x 25

Contattateci per richiedere i codici delle viti non presenti in tabella.
Contact us to know the part number (code) of not listed screws.

VITI A TENÒ PER MONTAGGIO MOLE /
TENÒ SCREWS FOR WHEELS

In acciaio / Steel

FILETTATURA
THREAD

M8

M10

POS. 3 BI POWER

M8 M10

PROFILO PROFILES	COD.	DIMENSIONE DIMENSION	COD.	DIMENSIONE DIMENSION
A20 r10	SA06004	M8 x 15	SA07004	M10 x 15
A30 r5	SA06004	M8 x 15	SA07004	M10 x 15
A30 r15	SA06004	M8 x 15	SA07004	M10 x 15
A30 r20	SA06004	M8 x 15	SA07004	M10 x 15
A40 r20	SA06004	M8 x 15	SA07004	M10 x 15
B20	SA06004	M8 x 15	SA07004	M10 x 15
B30	SA06004	M8 x 15	SA07004	M10 x 15
E30	SA06004	M8 x 15	SA07004	M10 x 15
F20	SA06004	M8 x 15	SA07004	M10 x 15
F30	SA06004	M8 x 15	SA07004	M10 x 15
FZ30	SA06004	M8 x 15	SA07004	M10 x 15
H20	SA06004	M8 x 15	SA07004	M10 x 15
H30	SA06004	M8 x 15	SA07004	M10 x 15
H+A30	SA06004	M8 x 15	SA07004	M10 x 15
L20	SA06004	M8 x 15	SA07004	M10 x 15
L30	SA06004	M8 x 15	SA07004	M10 x 15
O20	SA06004	M8 x 15	SA07004	M10 x 15
O30	SA06004	M8 x 15	SA07004	M10 x 15
OG30	SA06004	M8 x 15	SA07004	M10 x 15
Q20	SA06004	M8 x 15	SA07004	M10 x 15
Q30	SA06004	M8 x 15	SA07004	M10 x 15
T20 r5	SA06004	M8 x 15	SA07004	M10 x 15
T30 r3	SA06004	M8 x 15	SA07004	M10 x 15
T30 r5	SA06004	M8 x 15	SA07004	M10 x 15
T30 r10	SA06004	M8 x 15	SA07004	M10 x 15
T40 r3,5	SA06004	M8 x 15	SA07004	M10 x 15
TP30	SA06004	M8 x 15	SA07004	M10 x 15
V20	SA06004	M8 x 15	SA07004	M10 x 15
V30	SA06004	M8 x 15	SA07004	M10 x 15
V31,7	SA06004	M8 x 15	SA07004	M10 x 15
V40	SA06004	M8 x 15	SA07004	M10 x 15
V50	SA06004	M8 x 15	SA07004	M10 x 15
V60	SA06004	M8 x 15	SA07004	M10 x 15
YS20 3x3	SA06004	M8 x 15	SA07004	M10 x 15
YS30 3x3	SA06004	M8 x 15	SA07004	M10 x 15
Z30	SA06004	M8 x 15	SA07004	M10 x 15
ZS20	SA06004	M8 x 15	SA07004	M10 x 15
ZS30	SA06004	M8 x 15	SA07004	M10 x 15

Contattateci per richiedere i codici delle viti non presenti in tabella.
Contact us to know the part number (code) of not listed screws.

MOLE SAGOMATE LINEA IW / LINE IW PROFILE WHEELS

KIT PER **GRANITO** / KIT PER **MARMO**
GRANITE SET / MARBLE SET

Kit completo dalla sgrossatura alla lucidatura per macchine MASTER, GHINES ed altre. Linea completa di mole a profilo da una sgrossatura veloce ad una lucidatura brillante grazie alle tecnologie brevettate Marmoelettromeccanica quali Frangistone e Long-Life. Mole sagomate che possono essere montate su tutte le macchine manuali che lavorano con utensili dotati di tastatore rotante, sia con vite M8 che con vite M10. Con l'impiego dell'intero kit otterrete: massimo grado di lucentezza, totale assenza di righe ed ondulazioni, lavorazione senza polvere e nessuna lavorazione manuale aggiuntiva.

Complete set for all steps of the polishing process for MASTER, GHINES and other machines. Complete line of profiling wheels for all steps of the polishing process. They are provided with the exclusive Marmoelettromeccanica technologies, such as Frangistone and Long-Life. These wheels can be mounted on all manual machines that employ rotating touchers with M8 or M10 screws.

By utilizing the entire kit you will obtain: perfect polish, total absence of scratches or lines, reduced production of dust and no need to further rectify by hand.

PROFILI STANDARD / STANDARD PROFILES



!
Su richiesta
è disponibile
qualsiasi altro
profilo

Available any
other profile
on request



SPECIFICHE TECNICHE / TECHNICAL DATA

Passaggio acqua interno. Foro standard 22,2 mm.
Standard bore 22,2 mm. Internal water feed.

POS. 00



Mola Pre-Taglio /
Pre-Cutting Wheel

FRANGISTONE

LA MOLA BREVETTATA CHE TAGLIA COSTI E TEMPI
Per velocizzare i tempi di lavorazione offriamo l'innovativa e brevettata mola FRANGISTONE che frantumando già il 60% della pietra riduce costi e tempi di almeno quattro volte rispetto alla tecnologia tradizionale, garantendo una velocissima asportazione ed una lunga durata alle mole successive. Per granito, agglomerati di quarzo e pietre dure.

THE PATENTED WHEEL THAT CUTS COSTS
For the purpose of shortening the working times we offer the new and patented FRANGISTONE wheel, in itself able to grind 60% of the stone, therefore reducing to one fourth at most the delays and expenses of each project. The durability of the second step wheel is also improved.
For granite, quartz and hard stones.

POS. 0



SETTORI / SEGMENTED

SGROSSATURA VELOCE SU MATERIALI DURI
Le mole a settori garantiscono una veloce asportazione su materiali molto duri. La mola a settori garantisce un maggiore scarico e lubrificazione rispetto alle mole sinterizzate a fascia continua. Altezza settori 5 mm. Granito, agglomerati di quarzo e pietre dure.

FAST GRINDING ON HARD MATERIALS
The new Razorstone wheel, born from Frangistone technology, allows a 5 time faster grinding than the traditional segmented wheels. It has a longer lifespan and grants it to the following wheels too.
For granite, quartz and hard stones.

POS. 1-2-3



ZENITH

SGROSSATURA

Le mole con tastatore rotante per la profilatura che garantiscono eccezionale potere di asportazione e costante mantenimento del profilo per tutta la loro durata, grazie alle nostre tecnologie innovative. Per granito, agglomerati di quarzo, pietre dure e ceramica.

GRINDING

Profiling wheels with rotating toucher offering the strongest grinding power and an even retention of profile for their entire duration, thanks to our exclusive technologies. For granite, quartz and hard stones.

BIPOWER

LA MOLA RETTIFICATRICE CHE NON SI DEFORMA

La mola indeformabile per una perfetta rettifica del profilo. Grazie a questa mola le successive mole lucidanti potranno lavorare in condizioni ottimali per una maggiore durata ed il massimo grado di lucentezza finale. Per granito, agglomerati di quarzo, marmi e pietre.

THE RECTIFICATION WHEEL THAT NEVER LOSES ITS SHAPE

The non-deformable wheel for the perfect profile rectification. Thanks to its work the following polishing wheels will work in ideal conditions, have a longer lifespan and grant the perfect final polishing. For granite, quartz, marble and hard stones.

POS. 4-5-6



LONG LIFE

L'INNOVATIVO SISTEMA DI LUCIDATURA

Costruite con pregiatissimo diamante stampato su corpo elastico, garantiscono una serie di vantaggi quali lunghissima durata, tempi di lavorazione dimezzati, totale assenza di righe, eccezionale grado di lucentezza con risultati insuperabili su marmi, graniti ed agglomerati di quarzo. Per granito, agglomerati di quarzo, marmi e pietre.

THE INNOVATIVE POLISHING SYSTEM

Made with precious diamonds molded onto an elastic rubber core, these tools offer multiply advantages: long life span, reduced process times, absence of lines, outstanding polish and deep gloss on marble, granites and quartz.

For granite, quartz, marble and other stones.

POS. 1-2-3



ELETTROLITICA / ELECTROPLATED

SGROSSATURA MARMO

Le mole elettrolitiche con tastatore rotante costruite secondo i più moderni ed avanzati sistemi di elettrodeposizione, caratteristiche che consentono all'utensile di avere un ottimo potere di asportazione ed una lunga durata. Per marmi e pietre tenere.

GRINDING - MARBLE

Electroplated wheels with rotating toucher built with the most modern and efficient methods of electroplating, therefore offering the best grinding power obtainable and a long durability. For marble and soft stones.

BIPOWER

LA MOLA RETTIFICATRICE CHE NON SI DEFORMA

La mola indeformabile per una perfetta rettifica del profilo. Grazie a questa mola le successive mole lucidanti potranno lavorare in condizioni ottimali per una maggiore durata ed il massimo grado di lucentezza finale. Per granito, agglomerati di quarzo, marmi e pietre.

THE RECTIFICATION WHEEL THAT NEVER LOSES ITS SHAPE

The non-deformable wheel for the perfect profile rectification. Thanks to its work the following polishing wheels will work in ideal conditions, have a longer life-span and grant the perfect final polishing. For granite, quartz, marble and hard stones.

POS. 4-5-6



LONG LIFE

L'INNOVATIVO SISTEMA DI LUCIDATURA

Costruite con pregiatissimo diamante stampato su corpo elastico, garantiscono una serie di vantaggi quali lunghissima durata, tempi di lavorazione dimezzati, totale assenza di righe, eccezionale grado di lucentezza con risultati insuperabili su marmi, graniti ed agglomerati di quarzo. Per granito, agglomerati di quarzo, marmi e pietre.

THE INNOVATIVE POLISHING SYSTEM

Made with precious diamonds molded onto an elastic rubber core, these tools offer multiply advantages: long life span, reduced process times, absence of lines, outstanding polish and deep gloss on marble, granites and quartz. For granite, quartz, marble and other stones.

MOLE SAGOMATE LINEA IW / LINE IW PROFILE WHEELS

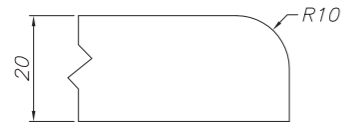

A20 r10

COD.	TIPO MOLA WHEEL TYPE	POS.	MATERIALE MATERIAL
SS61002	Zenith	1	● ● ●
SS62002	Zenith	2	● ● ●
SS63002	Bi Power	3	● ● ● ●
SS64002	Long Life	4	● ● ● ●
SS65002	Long Life	5	● ● ● ●
SS66002	Long Life	6	● ● ● ●
SS67002	Elettrolitica / Electroplated	1	○
SS68002	Elettrolitica / Electroplated	2	○

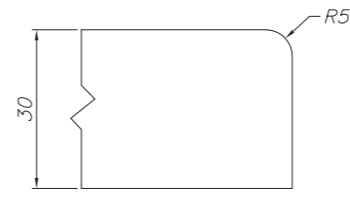

A30 r5

COD.	TIPO MOLA WHEEL TYPE	POS.	MATERIALE MATERIAL
SS61005	Zenith	1	● ● ●
SS62005	Zenith	2	● ● ●
SS63005	Bi Power	3	● ● ● ●
SS64005	Long Life	4	● ● ● ●
SS65005	Long Life	5	● ● ● ●
SS66005	Long Life	6	● ● ● ●
SS67005	Elettrolitica / Electroplated	1	○
SS68005	Elettrolitica / Electroplated	2	○

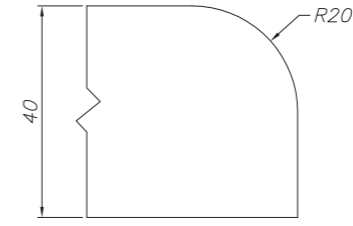

A40 r20

COD.	TIPO MOLA WHEEL TYPE	POS.	MATERIALE MATERIAL
SS72021	Frangistone	00	○ ●
SS61021	Zenith	1	● ● ●
SS62021	Zenith	2	● ● ●
SS63021	Bi Power	3	● ● ● ●
SS64021	Long Life	4	● ● ● ●
SS65021	Long Life	5	● ● ● ●
SS66021	Long Life	6	● ● ● ●
SS67021	Elettrolitica / Electroplated	1	○
SS68021	Elettrolitica / Electroplated	2	○

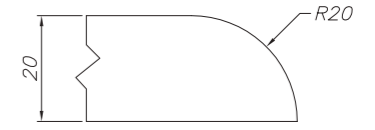

B20

COD.	TIPO MOLA WHEEL TYPE	POS.	MATERIALE MATERIAL
SS72026	Frangistone	00	○ ●
SS61026	Zenith	1	● ● ●
SS62026	Zenith	2	● ● ●
SS63026	Bi Power	3	● ● ● ●
SS64026	Long Life	4	● ● ● ●
SS65026	Long Life	5	● ● ● ●
SS66026	Long Life	6	● ● ● ●
SS67026	Elettrolitica / Electroplated	1	○
SS68026	Elettrolitica / Electroplated	2	○

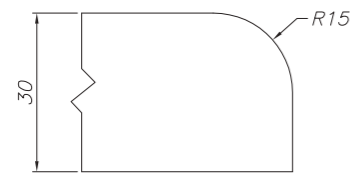

A30 r15

COD.	TIPO MOLA WHEEL TYPE	POS.	MATERIALE MATERIAL
SS72009	Frangistone	00	○ ●
SS61009	Zenith	1	● ● ●
SS62009	Zenith	2	● ● ●
SS63009	Bi Power	3	● ● ● ●
SS64009	Long Life	4	● ● ● ●
SS65009	Long Life	5	● ● ● ●
SS66009	Long Life	6	● ● ● ●
SS67009	Elettrolitica / Electroplated	1	○
SS68009	Elettrolitica / Electroplated	2	○

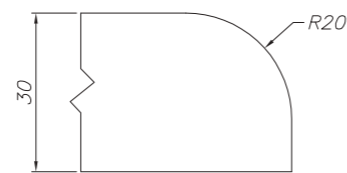

A30 r20

COD.	TIPO MOLA WHEEL TYPE	POS.	MATERIALE MATERIAL
SS72010	Frangistone	00	○ ●
SS61010	Zenith	1	● ● ●
SS62010	Zenith	2	● ● ●
SS63010	Bi Power	3	● ● ● ●
SS64010	Long Life	4	● ● ● ●
SS65010	Long Life	5	● ● ● ●
SS66010	Long Life	6	● ● ● ●
SS67010	Elettrolitica / Electroplated	1	○
SS68010	Elettrolitica / Electroplated	2	○

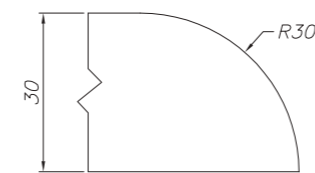

B30

COD.	TIPO MOLA WHEEL TYPE	POS.	MATERIALE MATERIAL
SS72027	Frangistone	00	○ ●
SS60027	Settori/ Segmented	0	○ ●
SS61027	Zenith	1	● ● ●
SS62027	Zenith	2	● ● ●
SS63027	Bi Power	3	● ● ● ●
SS64027	Long Life	4	● ● ● ●
SS65027	Long Life	5	● ● ● ●
SS66027	Long Life	6	● ● ● ●
SS67027	Elettrolitica / Electroplated	1	○
SS68027	Elettrolitica / Electroplated	2	○

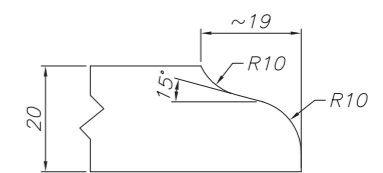

F20

COD.	TIPO MOLA WHEEL TYPE	POS.	MATERIALE MATERIAL
SS72049	Frangistone	00	○ ●
SS60049	Settori/ Segmented	0	○ ●
SS61049	Zenith	1	● ● ●
SS62049	Zenith	2	● ● ●
SS63049	Bi Power	3	● ● ● ●
SS64049	Long Life	4	● ● ● ●
SS65049	Long Life	5	● ● ● ●
SS66049	Long Life	6	● ● ● ●
SS67049	Elettrolitica / Electroplated	1	○
SS68049	Elettrolitica / Electroplated	2	○

**LEGENDA MATERIALE
LEGEND MATERIAL:**



**LEGENDA MATERIALE
LEGEND MATERIAL:**



MOLE SAGOMATE LINEA IW / LINE IW PROFILE WHEELS

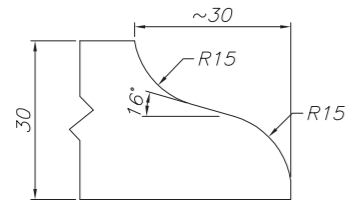

F30

COD.	TIPO MOLA WHEEL TYPE	POS.	MATERIALE MATERIAL
SS72050	Frangistone	00	○ ○
SS60050	Settori/ Segmented	0	○ ○
SS61050	Zenith	1	○ ○ ○
SS62050	Zenith	2	○ ○ ○
SS63050	Bi Power	3	○ ○ ○ ○
SS64050	Long Life	4	○ ○ ○ ○
SS65050	Long Life	5	○ ○ ○ ○
SS66050	Long Life	6	○ ○ ○ ○
SS67050	Elettrolitica / Electroplated	1	○
SS68050	Elettrolitica / Electroplated	2	○

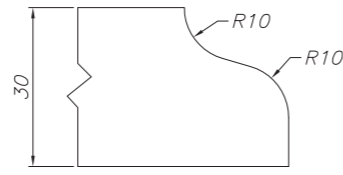

FZ30

COD.	TIPO MOLA WHEEL TYPE	POS.	MATERIALE MATERIAL
SS72074	Frangistone	00	○ ○
SS60074	Settori/ Segmented	0	○ ○
SS61074	Zenith	1	○ ○ ○
SS62074	Zenith	2	○ ○ ○
SS63074	Bi Power	3	○ ○ ○ ○
SS64074	Long Life	4	○ ○ ○ ○
SS65074	Long Life	5	○ ○ ○ ○
SS66074	Long Life	6	○ ○ ○ ○
SS67074	Elettrolitica / Electroplated	1	○
SS68074	Elettrolitica / Electroplated	2	○

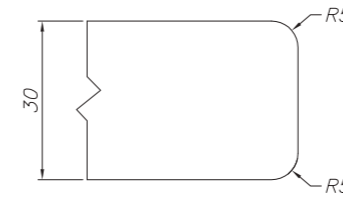

T30 r5

COD.	TIPO MOLA WHEEL TYPE	POS.	MATERIALE MATERIAL
SS61082	Zenith	1	○ ○ ○
SS62082	Zenith	2	○ ○ ○
SS63082	Bi Power	3	○ ○ ○ ○
SS64082	Long Life	4	○ ○ ○ ○
SS65082	Long Life	5	○ ○ ○ ○
SS66082	Long Life	6	○ ○ ○ ○
SS67082	Elettrolitica / Electroplated	1	○
SS68082	Elettrolitica / Electroplated	2	○

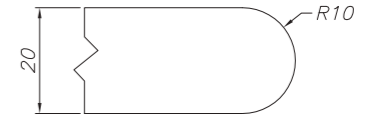

V20

COD.	TIPO MOLA WHEEL TYPE	POS.	MATERIALE MATERIAL
SS61087	Zenith	1	○ ○ ○
SS62087	Zenith	2	○ ○ ○
SS63087	Bi Power	3	○ ○ ○ ○
SS64087	Long Life	4	○ ○ ○ ○
SS65087	Long Life	5	○ ○ ○ ○
SS66087	Long Life	6	○ ○ ○ ○
SS67087	Elettrolitica / Electroplated	1	○
SS68087	Elettrolitica / Electroplated	2	○

Utensili per Macchine Manuali e Semi-automatiche
Tools for Manual and Semi-Automatic Machines

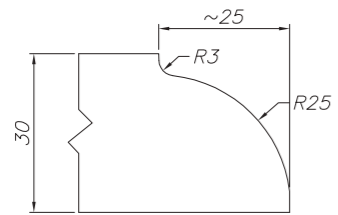

H30

COD.	TIPO MOLA WHEEL TYPE	POS.	MATERIALE MATERIAL
SS72057	Frangistone	00	○ ○
SS60057	Settori/ Segmented	0	○ ○
SS61057	Zenith	1	○ ○ ○
SS62057	Zenith	2	○ ○ ○
SS63057	Bi Power	3	○ ○ ○ ○
SS64057	Long Life	4	○ ○ ○ ○
SS65057	Long Life	5	○ ○ ○ ○
SS66057	Long Life	6	○ ○ ○ ○
SS67057	Elettrolitica / Electroplated	1	○
SS68057	Elettrolitica / Electroplated	2	○

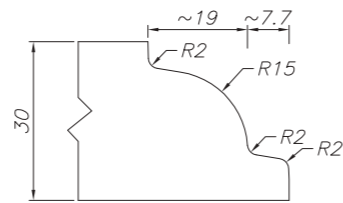

H+A30

COD.	TIPO MOLA WHEEL TYPE	POS.	MATERIALE MATERIAL
SS72060	Frangistone	00	○ ○
SS60060	Settori/ Segmented	0	○ ○
SS61060	Zenith	1	○ ○ ○
SS62060	Zenith	2	○ ○ ○
SS63060	Bi Power	3	○ ○ ○ ○
SS64060	Long Life	4	○ ○ ○ ○
SS65060	Long Life	5	○ ○ ○ ○
SS66060	Long Life	6	○ ○ ○ ○
SS67060	Elettrolitica / Electroplated	1	○
SS68060	Elettrolitica / Electroplated	2	○

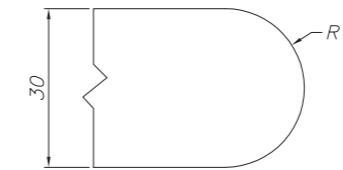

V30

COD.	TIPO MOLA WHEEL TYPE	POS.	MATERIALE MATERIAL
SS72088	Frangistone	00	○ ○
SS60088	Settori/ Segmented	0	○ ○
SS61088	Zenith	1	○ ○ ○
SS62088	Zenith	2	○ ○ ○
SS63088	Bi Power	3	○ ○ ○ ○
SS64088	Long Life	4	○ ○ ○ ○
SS65088	Long Life	5	○ ○ ○ ○
SS66088	Long Life	6	○ ○ ○ ○
SS67088	Elettrolitica / Electroplated	1	○
SS68088	Elettrolitica / Electroplated	2	○

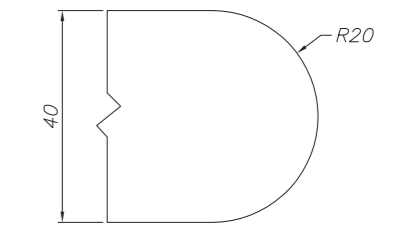

V40

COD.	TIPO MOLA WHEEL TYPE	POS.	MATERIALE MATERIAL
SS72090	Frangistone	00	○ ○
SS60090	Settori/ Segmented	0	○ ○
SS61090	Zenith	1	○ ○ ○
SS62090	Zenith	2	○ ○ ○
SS63090	Bi Power	3	○ ○ ○ ○
SS64090	Long Life	4	○ ○ ○ ○
SS65090	Long Life	5	○ ○ ○ ○
SS66090	Long Life	6	○ ○ ○ ○
SS67090	Elettrolitica / Electroplated	1	○
SS68090	Elettrolitica / Electroplated	2	○

**LEGENDA MATERIALE
LEGEND MATERIAL:**



**LEGENDA MATERIALE
LEGEND MATERIAL:**



MOLE SAGOMATE LINEA IW / LINE IW PROFILE WHEELS

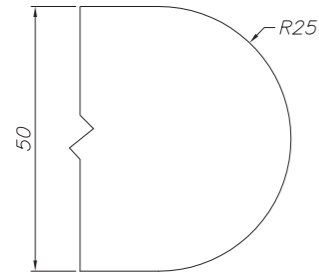

V50

COD.	TIPO MOLA WHEEL TYPE	POS.	MATERIALE MATERIAL
SS72092	Frangistone	00	○ ○
SS60092	Settori/ Segmented	0	○ ○
SS61092	Zenith	1	○ ○ ○
SS62092	Zenith	2	○ ○ ○
SS63092	Bi Power	3	○ ○ ○ ○
SS64092	Long Life	4	○ ○ ○ ○
SS65092	Long Life	5	○ ○ ○ ○
SS66092	Long Life	6	○ ○ ○ ○
SS67092	Elettrolitica / Electroplated	1	○
SS68092	Elettrolitica / Electroplated	2	○

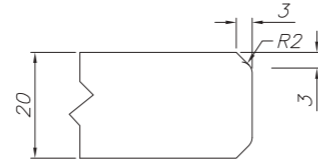

YS20

COD.	TIPO MOLA WHEEL TYPE	POS.	MATERIALE MATERIAL
SS61120	Zenith	1	○ ○ ○
SS62120	Zenith	2	○ ○ ○
SS63120	Bi Power	3	○ ○ ○ ○
SS64120	Long Life	4	○ ○ ○ ○
SS65120	Long Life	5	○ ○ ○ ○
SS66120	Long Life	6	○ ○ ○ ○
SS67120	Elettrolitica / Electroplated	1	○
SS68120	Elettrolitica / Electroplated	2	○

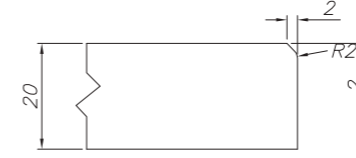

ZS20

COD.	TIPO MOLA WHEEL TYPE	POS.	MATERIALE MATERIAL
SS61040	Zenith	1	○ ○ ○
SS62040	Zenith	2	○ ○ ○
SS63040	Bi Power	3	○ ○ ○ ○
SS64040	Long Life	4	○ ○ ○ ○
SS65040	Long Life	5	○ ○ ○ ○
SS66040	Long Life	6	○ ○ ○ ○
SS67040	Elettrolitica / Electroplated	1	○
SS68040	Elettrolitica / Electroplated	2	○

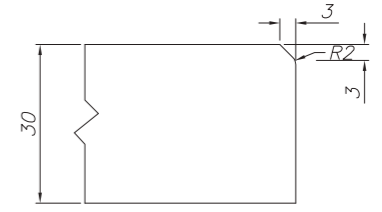

ZS30

COD.	TIPO MOLA WHEEL TYPE	POS.	MATERIALE MATERIAL
SS61041	Zenith	1	○ ○ ○
SS62041	Zenith	2	○ ○ ○
SS63041	Bi Power	3	○ ○ ○ ○
SS64041	Long Life	4	○ ○ ○ ○
SS65041	Long Life	5	○ ○ ○ ○
SS66041	Long Life	6	○ ○ ○ ○
SS67041	Elettrolitica / Electroplated	1	○
SS68041	Elettrolitica / Electroplated	2	○

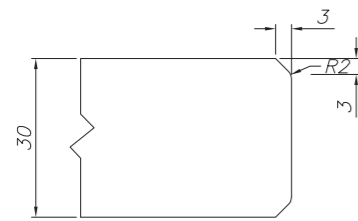

YS30 3x3

COD.	TIPO MOLA WHEEL TYPE	POS.	MATERIALE MATERIAL
SS61121	Zenith	1	○ ○ ○
SS62121	Zenith	2	○ ○ ○
SS63121	Bi Power	3	○ ○ ○ ○
SS64121	Long Life	4	○ ○ ○ ○
SS65121	Long Life	5	○ ○ ○ ○
SS66121	Long Life	6	○ ○ ○ ○
SS67121	Elettrolitica / Electroplated	1	○
SS68121	Elettrolitica / Electroplated	2	○

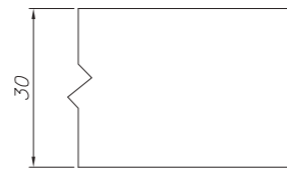

Z30

COD.	TIPO MOLA WHEEL TYPE	POS.	MATERIALE MATERIAL
SS61034	Zenith	1	○ ○ ○
SS62034	Zenith	2	○ ○ ○
SS63034	Bi Power	3	○ ○ ○ ○
SS64034	Long Life	4	○ ○ ○ ○
SS65034	Long Life	5	○ ○ ○ ○
SS66034	Long Life	6	○ ○ ○ ○
SS67034	Elettrolitica / Electroplated	1	○
SS68034	Elettrolitica / Electroplated	2	○



TASTATORE ROTANTE / ROTATING TOUCHER

In acciaio super rapido temperato / Tempered Steel

COD.	DESCRIZIONE DESCRIPTION
SA05001	Per mole sagomate profili aperti / For open profile wheels
SA05002	Per mole sagomate profili chiusi / For closed profile wheels
SA05003	Per mole Frangistone profili aperti / For open Frangistone wheels
SA05004	Per mole Frangistone profili chiusi / For closed Frangistone wheels



ADATTATORE / ADAPTOR

In acciaio / Steel

COD.	ATTACCO FITTING	L (mm)	L Tot (mm)
SA02001	1/2" Gas	28,0	82,5
SA02002	5/8" x 11 UNC	28,0	74,5

**LEGENDA MATERIALE
LEGEND MATERIAL:**



**LEGENDA MATERIALE
LEGEND MATERIAL:**



SCONTORNATRICE MASTER 3500 / MASTER 3500 ROUTER

La Master 3500 è una scontornatrice elettrica portatile con piastra di scorrimento "WATER SYSTEM", un dispositivo di scorrimento su un velo d'acqua che si interpone tra la macchina e la superficie da lavorare, garantendo così la non rigatura dei piani. La Master 3500 è costruita con materiali selezionatissimi, scelti tra i migliori produttori di materie prime.

Master 3500 is a portable electric contouring machine with "WATER SYSTEM" base board which creates a gliding water film between the machine and the slab. This system immediately eliminates the stone pieces broken during the working without scratching the surfaces. The Master 3500 machine is built with high-quality material, only coming from the best suppliers.

RISPONDEZZA ALLE NORME INTERNAZIONALI / COMPLIANCE WITH INTERNATIONAL REGULATIONS

NORME DIMENSIONALI
DIMENSIONAL STANDARDS

UNEL
13113-71
UNEL
13117
13118-71

NORME DIMENSIONALI
DIMENSIONAL STANDARDS

CEI
2-3/88

PROTEZIONI MECCANICHE
MECHANICAL PROTECTIONS

CEI
2-16/88

FORME COSTRUTTIVE
STRUCTURAL SHAPE

CEI
2-4/85

VIBRAZIONI MECCANICHE
MECHANICAL VIBRATIONS

ISO
2372

METODO DI RAFFREDDAMENTO
XXX

CEI
2-7978





COD.	PIASTRA BASE BOARD
MASTER0006	Water System
MASTER0007	Con ruote Rollers base board



SCONTORNATRICE MASTER 3500 / MASTER 3500 ROUTER

Velocità variabile / Variable speed

- **Commutatore di velocità per variare il numero di giri della mola, adattandola ad ogni propria specifica esigenza** / A switch that varies the speed at which the profiling wheels turn thus allowing you to adapt it to each and every type of work
- **Velocità del mandrino variabile: RPM 3000/6000** / Variable shaft speed: rpm 2800/5600
- **Struttura meccanica in alluminio, anticorrosione e acciaio INOX** / Mechanical structure in aluminium, anticorrosion and stainless steel
- **Viterie in acciaio INOX** / Screws Steel
- **Motore asincrono trifase 3,5HP, 48 volts, 50/60 Hz** / Asynchronous threephase motor 3,5 HP, 48 volts, 50/60 hz
- **Carrozzeria in polipropilene ignifugo (super-leggera)** / Housing in fireproof polypropylene (super-light)
- **Trattamenti: parti meccaniche del tipo galvanico estetiche verniciatura a caldo** / Special treatment: mechanical parts are galvanized, aesthetic part are heat painted
- **Tipo 100/R, F3, RPM 1400/2800** / Type 100/r, f3, rpm 1400/2800
- **Trasmissione Poly/V, 10 J** / Transmission poly/v, 10 J
- **Isolamento CH, term. 140° C** / Isolation ch, term. 140 °C
- **È dotata di segnalazioni luminose (Legge 626) che indicano "macchina in funzione"** / It is equipped with indicators to show that the machine is on (Italian law 626)

CENTRALINA ELETTRICA / ELECTRICAL CONVERSION UNIT

La Centralina elettrica di sicurezza è conforme alle normative di sicurezza internazionali. Può essere collegata alla Master 3500, Master 2800 e Laser 4000.

Safety electrical conversion unit MEM3000 - 220v or 380v constructed according to the international safety regulations. It can be connected to MASTER 3500 and LASER 4000 machines.

COD.	W	V	MACCHINA MACHINE
CENTRA3000220	3000	220	Master 3500
CENTRA3000380	3000	380	Master 3500
CENTRA3000415	3000	415	Master 3500
CENTRA1500220	1500	220	Master 2800
CENTRA1500380	1500	380	Master 2800
CENTRA1500415	1500	415	Master 2800

- **Centralina elettrica 3000 - 1500 W** / Electric conversion unit 3000 - 1500 W
- **Entrata 380 - 220 - 415 volt** / Input 380 - 220 - 415 volt
- **Uscita 48 volt (su richiesta altri voltaggi)** / Output 48 volt (others on request)
- **Con doppio schermo di isolamento** / With double insulation
- **Risponde alle norme internazionali di sicurezza per la prevenzione degli infortuni sul lavoro** / Compliant to the international safety regulations
- **È dotata del marchio CE** / Supplied with CE Marking



PIASTRA CON RUOTE / ROLLERS BASE BOARD

Per MASTER 3500 / For MASTER 3500

Rappresenta un optional che si può montare sulla Master 3500 e consente di lavorare anche su superfici non lucidate. Può essere rimossa in qualsiasi momento.

It is an optional which can be mounted on the Master 3500 machine in order to work both on polished and rough slabs. It can be dismantled with ease.

COD.

PIASTRAPLUSCR



PIASTRA WATER SYSTEM / WATER SYSTEM FIXED BASE BOARD

Per MASTER 3500 / For MASTER 3500

È un optional che si può montare con la massima facilità sulla Master 3500 dotate di ruote, sostituendo la piastra di scorrimento con ruote.

It is an optional which can be mounted on a Master 3500 machine with rollers, substituting the gliding plate with rollers.

COD.

WATERSYSTEMM3



PIASTRA CON RUOTE / ROLLERS BASE BOARD

Per MASTER 2800 / For MASTER 2800

È un optional che si può montare sulla Master 2800 e consente di lavorare anche su superfici non lucidate. Può essere rimossa in qualsiasi momento.

It is an optional which can be mounted on the Master 2800 machine in order to work both on polished and rough slabs. It can be dismantled with ease.

COD.

PIASTRAPLUS28



DISPOSITIVO TRIVENTOSA / TRIPLE VACUUM DEVICE

Con sagoma / With template

Rappresenta un'eccellente soluzione per la rettifica del foro dei top da bagno. La ventosa aderisce sul piano d'appoggio e ha il compito di bloccare la sagoma in PVC e al tempo stesso di bloccare il top da bagno per consentire la rettifica del foro con la Master, la cui guida è garantita dalla sagoma in PVC.

It is the perfect solution to rectify the internal hole of bathroom tops. The suction cups hold the PVC template on the surface, while the Master machine makes the hole by following its shape.

COD.

DISPOTRIVENTO

* in fase di ordine definire le dimensioni /
Size needed has to be included with the order



SUPPORTO DI SOLLEVAMENTO / LIFTING SUPPORT

Posizionando la Master 3500 o Master 2800 sul supporto di sollevamento è possibile rettificare, profilare e lucidare il bordo interno del foro dei top. La macchina scorre nella zona interna del foro facilitando notevolmente la lavorazione. Completo della prolunga per mandrino.

By positioning the Master 2800 or 3500 machine on the lifting support it is possible to rectify, shape and polish the hole's internal edge of a top. The machine will then glide in the internal part of the hole, thus simplifying the work. Spindle extension included.

COD.

**MACCHINA
MACHINE**

SUPPORTOWA35	Master 3500
SUPPORTOWA28	Master 2800

CREDITS

PHOTO
studioventuno.eu

GRAPHIC DESIGN
studioventuno.eu

SEPTEMBER 2019



Via Flaminia km 41,000
00068 Rignano Flaminio - ROMA
Tel. +39 0761 5051 / Fax +39 0761 508388
info@marmoelettro.it

WWW.MARMOELETTRO.COM

